

TA-Balk T1 (Stålfot)

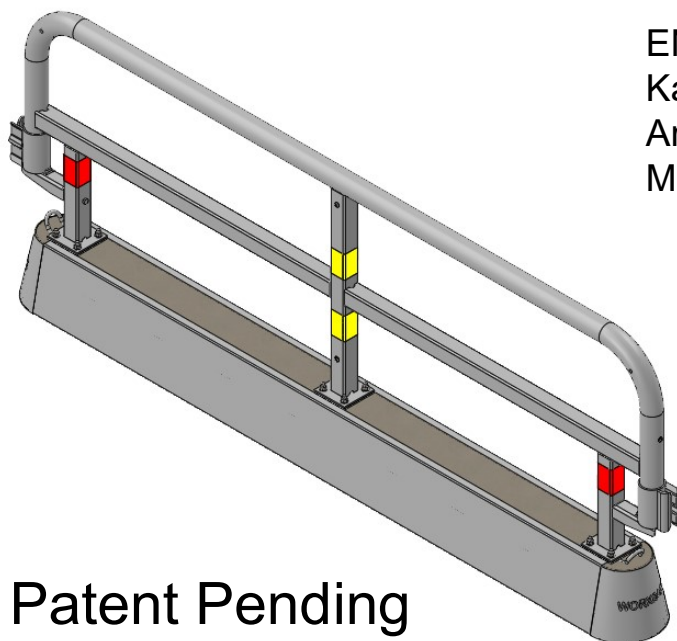

EN-1317

Kapacitetsklass : T1*

Arbetsbredd: W5(1,7 m)*

Min.installation längd: 72 m*

*Simulerade värden

Varmförzinkad



Stål & Betong



435

Patent Pending
Registered Designs

[mm]

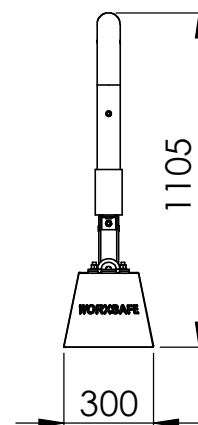
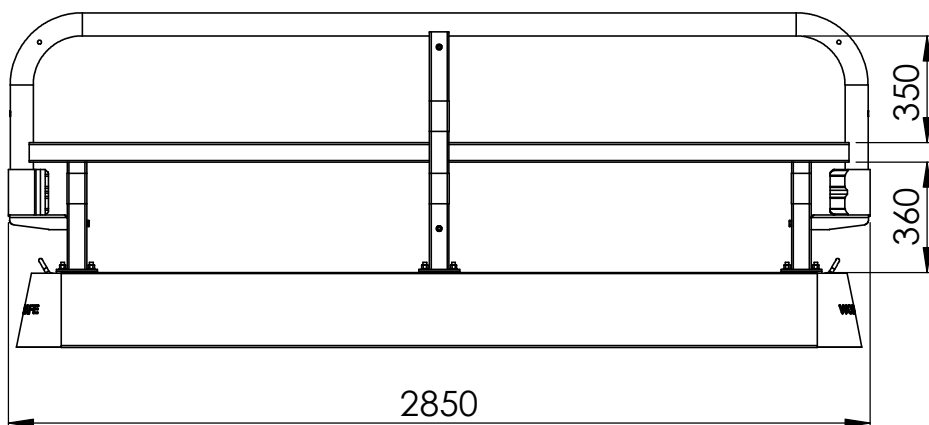

(Transportläge)

Montage

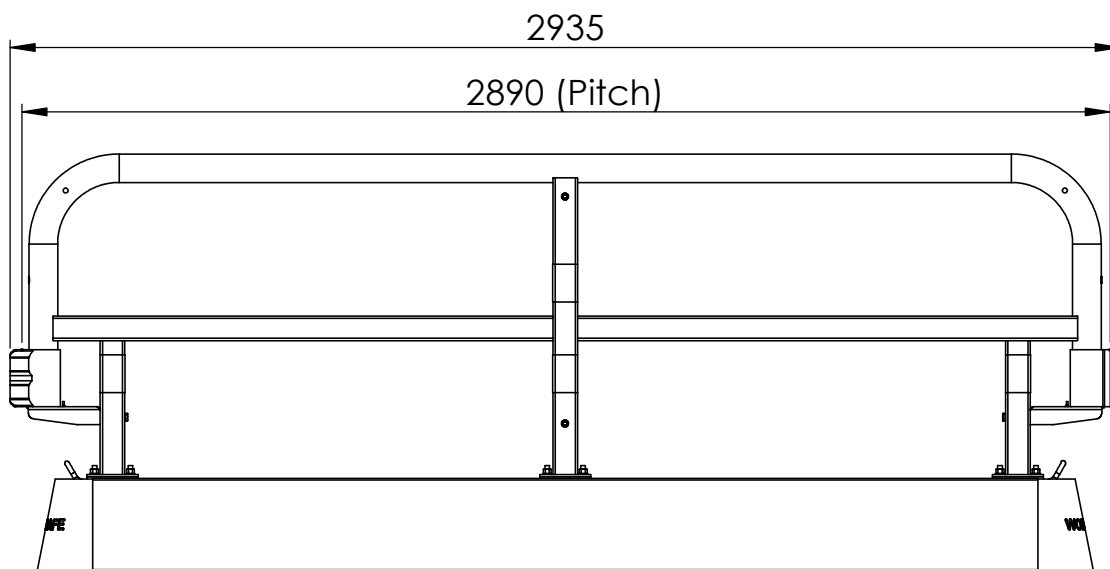
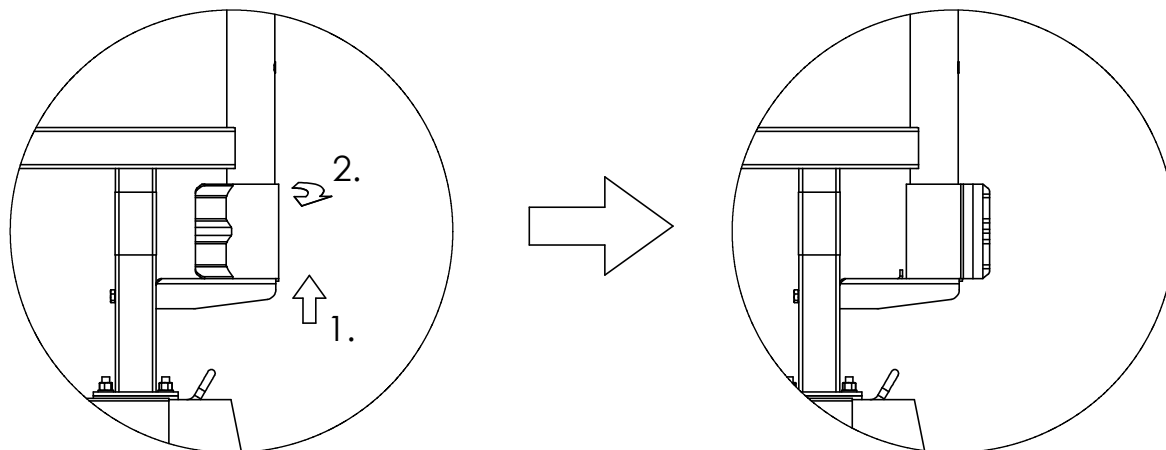

Montage

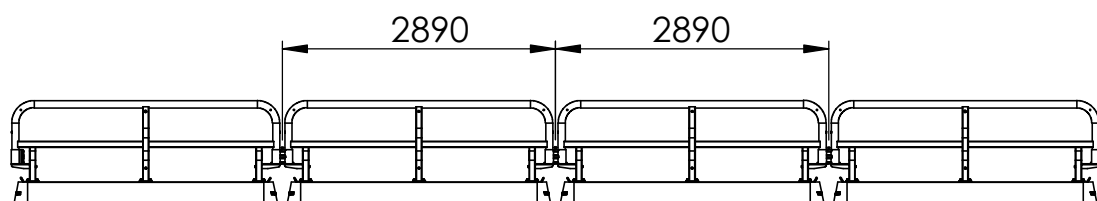
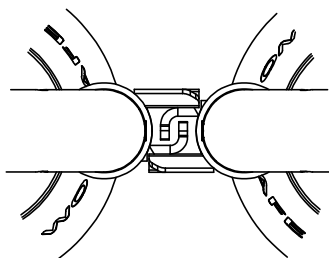
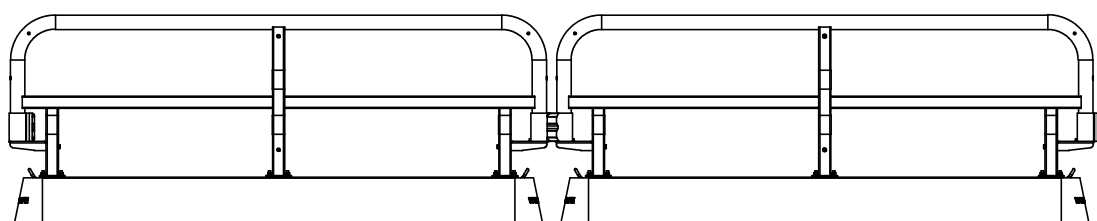
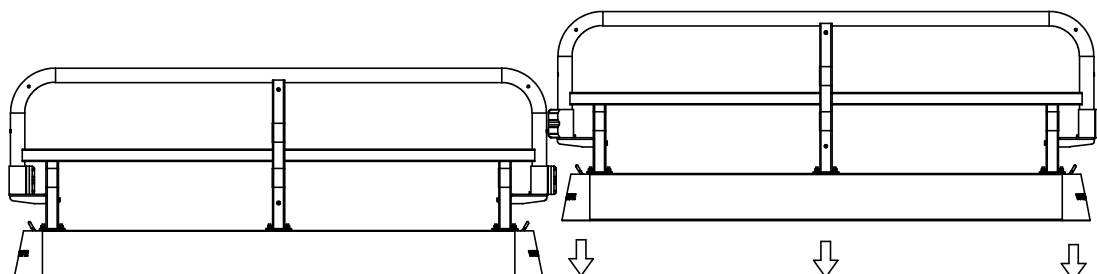

Håll händerna borta från kopplingsdelen vid lyft för att undvika klämnning.

Montage

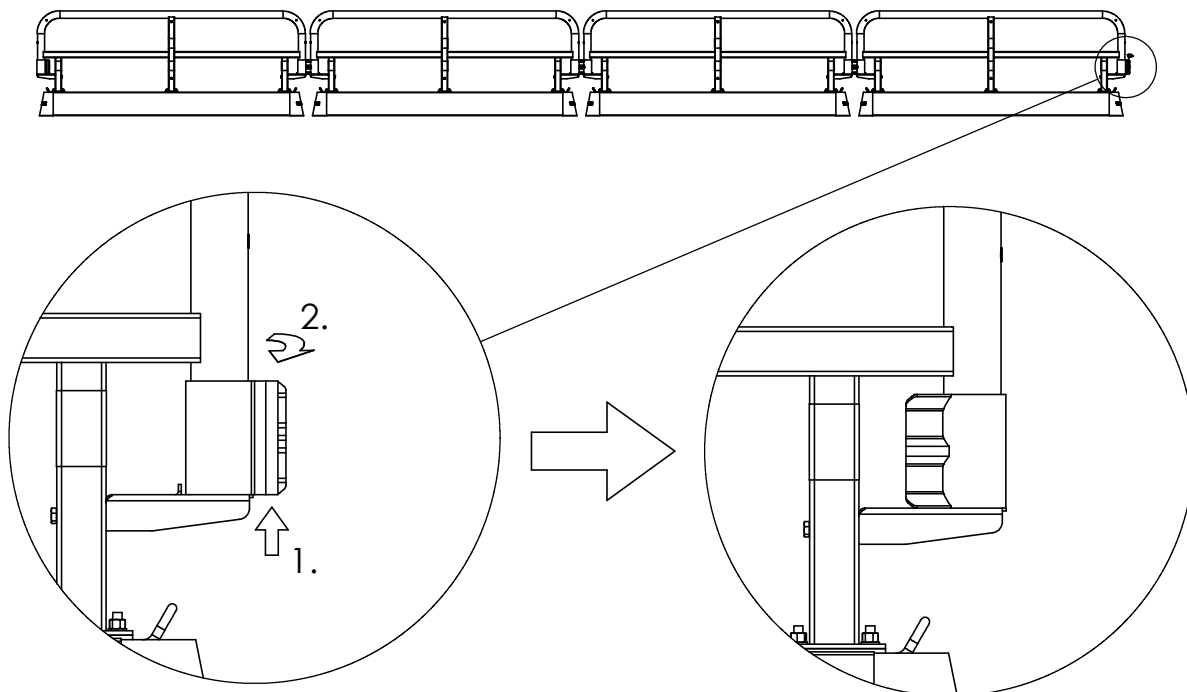

Produktfamilj

833000 TA-Balk (Stålfot)

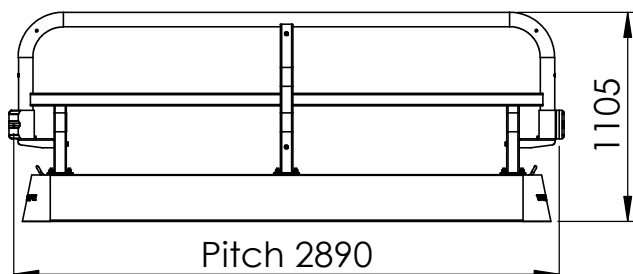

- Kapacitetsklass: T1*
- Arbetsbredd: W5 (1,7 m)*
- Min. installation längd: 72 m*

833001 TA-Balk (Gummifot)

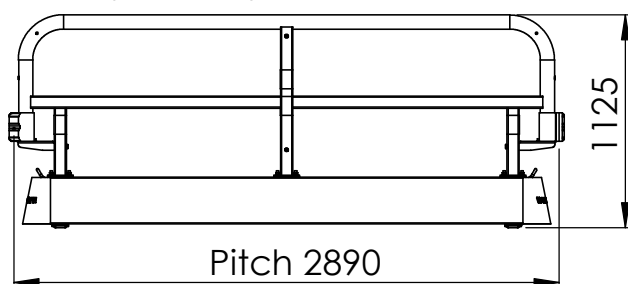

- Kapacitetsklass: T1*
- Arbetsklass: W3 (1,0 m)*
- Min. installation längd: 29 m*
- Kapacitetsklass: T2*
- Arbetsklass: W5 (1,7 m)*
- Min. installation längd: 87 m*

833002 TA-Balk (Stålfot)

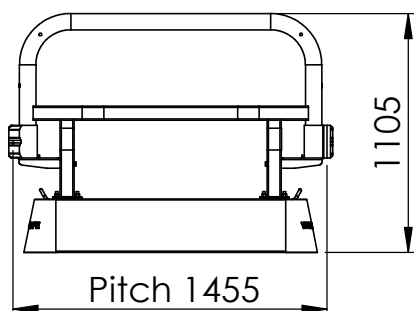

- För ökad flexibilitet

833003 TA-Balk (Gummifot)

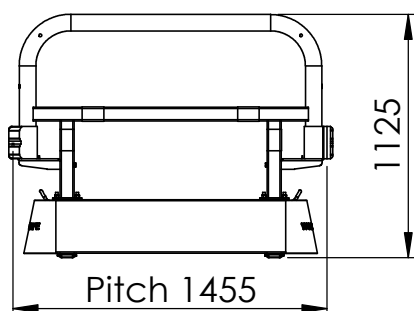

- För ökad flexibilitet

*Simulerade värden

GENERELLT















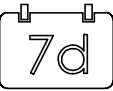

- Läs alltid igenom tillverkarens anvisningar för att säkerställa att produkten används på ett korrekt och säkert sätt.
- Vid oklarheter, kontakta tillverkaren eller aktuellt säljställe.
- Blanda aldrig produkter av olika fabrikat med varandra.
- Respektera alltid specificerade belastningsbegränsningar.

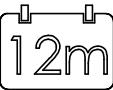
FÖRVARING

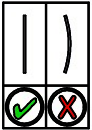
- Förvara i möjligaste mån produkterna i icke-korrosiv miljö.
- Tänk på att förvara produkterna på enligt tillverkaren avsett vis exempelvis vid stapling för att minimera risken för skador i samband med vältning eller liknande.

SPÅRBARHET

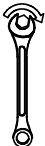
- Alla Worxsafe-produkter är spårbara via instansad märkning.

 Teknisk information	 Vikt	 Nm Momentdra skruvförband
 Inspektera	 Återvinning	 Lossa skruvförband
 Inspektionsintervall i dagar	 Korrekt	 Max tillåten vindhastighet
 Inspektionsintervall i månader	 Inkorrekt	 Kraft
 Kontrollera raket	 Se upp!	 Moment
 Kontrollera sprickbildning	 Drag åt skruvförband	 "Trä i"